

Product Code

7030/4M12

Nut

1/2"FlarexPipe12mm

PS = 50 bar

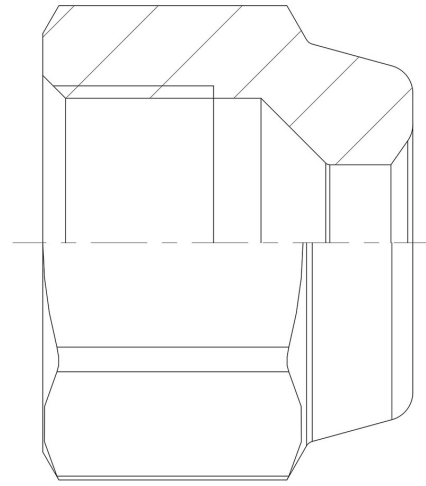

Product use

Accessories for use with the following ASHRAE 34:2019 refrigerants, Class A1, A2L, or A3:

- HCFC (R22)
- HFC (R134a, R32, R404A, R407C, R410A, R507)
- HFO and HFO/HFC blends (R1234ze, R1234yf, R448A, R449A, R450A, R452A, R513A, R515A, R515B)
- HC (R290, R600, R600a, R1270)
- R744

Product details

Internationaler code -

SAE Flare 1/2"

Kupferrohr Ø [in.] -

Kupferrohr Ø [mm] 12

PS [bar] 50

Verpackung 50

Notes

(1) Reduzierung