

Product Code

1437E/3S070

Solenoid Valve CO2

3/8" ODS w/o Coil

PS = 130 bar

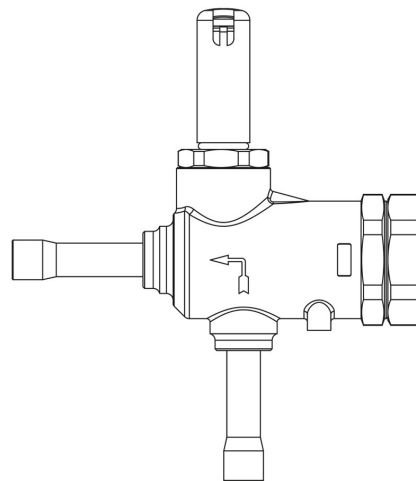

G O G R E E N

R744 • NATURAL REFRIGERANT

Product use

Accessories for use with refrigerant R744.

These valves are exclusively sold in the model without coil (S suffix).

Product details

Funtionsprinzip Kolbenantrieb

Spulentyp (1) HF3

Anschlüsse ODS Ø [in.] 3/8"

Anschlüsse ODS Ø [mm] -

Kv [m³/h] 1,1

PS [bar] 130

MWP [psi] (4) 1885

TS [°C] min. -40

TS [°C] max. +150

Verpackung 14

Notes

(1) : Spulen, die an den Ventilen montiert werden kann

(2): für den Einsatz in der Ölleitung TS = -10 / + 70 ° C

Castel non si assume alcuna responsabilità per eventuali errori nei cataloghi, opuscoli e altro materiale stampato o indicato nel sito Castel.it. Castel si riserva il diritto di modificare i propri prodotti senza preavviso. Tutti i marchi in questo materiale sono di proprietà di Castel. Tutti i diritti riservati.

Castel assumes no responsibility for any errors in catalogs, brochures and other material printed or indicated on the Castel.it website. Castel reserves the right to modify its products without notice. All trademarks in this material are the property of Castel. All rights reserved.

- (3): Zur Verwendung an der Ölleitung wenden Sie sich an CASTEL
(4): UL-Zulassung ausstehend