

Product Code

1428E/M10S030

Solenoid Valve CO2
10mm W w/o Coil
PS = 140 bar

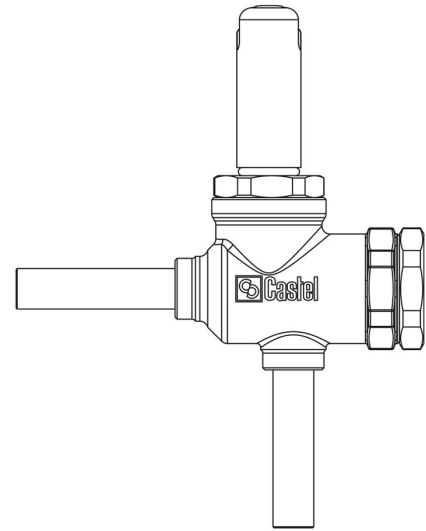

GO GREEN

R744 • NATURAL REFRIGERANT

Product use

Accessories for use with refrigerant R744.
These valves are exclusively sold in the model without coil (S suffix).

Product details

Funtionsprinzip	Kolbenantrieb
Spulentyp (1)	HF3
Anschlüsse ODS Ø [in.]	-
Anschlüsse ODS Ø [mm]	10
Kv [m ³ /h]	0,32
PS [bar]	140
MWP [psi] (4)	2030
TS [°C] min.	-40
TS [°C] max.	+150
Verpackung	14

Notes

(1) : Spulen, die an den Ventilen montiert werden kann
(2): für den Einsatz in der Ölleitung TS = -10 / + 70 ° C

Castel non si assume alcuna responsabilità per eventuali errori nei cataloghi, opuscoli e altro materiale stampato o indicato nel sito Castel.it. Castel si riserva il diritto di modificare i propri prodotti senza preavviso. Tutti i marchi in questo materiale sono di proprietà di Castel. Tutti i diritti riservati.

Castel assumes no responsibility for any errors in catalogs, brochures and other material printed or indicated on the Castel.it website. Castel reserves the right to modify its products without notice. All trademarks in this material are the property of Castel. All rights reserved.

- (3): Zur Verwendung an der Ölleitung wenden Sie sich an CASTEL
(4): UL-Zulassung ausstehend