

Product Code

1038EL/M10S

Solenoid Valve CO2
10mm ODS w/o Coil
PS = 60 bar

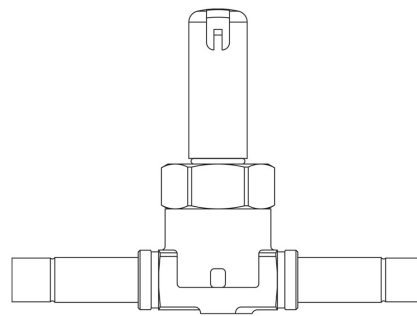

Product use

Accessories for use with refrigerant R744.

These valves are exclusively sold in the model without coil (S suffix).

Product details

Funtionsprinzip	Kolbenantrieb
Spulentyp (1)	HF3 (HM3)
Anschlüsse ODS Ø [in.]	-
Anschlüsse ODS Ø [mm]	10
Kv [m ³ /h]	1
PS [bar]	60
TS [°C] min.	-40
TS [°C] max.	+130
Verpackung	24

Notes

(1) : Spulen, die an den Ventilen montiert werden kann