

Product Code

1338N/M10S065

Pulse Solenoid Valve
10mm ODS w/o Coil
PS = 50 bar

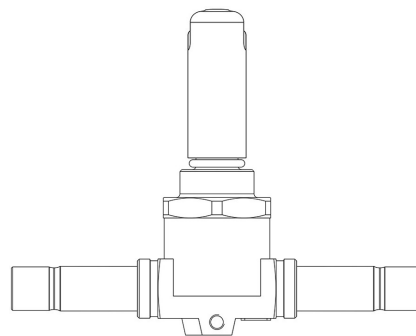

P  **LYHEDRA**

Product use

Accessories for use with the following ASHRAE 34:2019 refrigerants, Class A1, A2L, or A3:
HFC (R134A, R32, R404A, R407C, R410A, R507)
HFO (R1234YF, R1234ZE)
HFO + HFC (R448A, R449A, R450A, R452A, R452B, R454A, R454B, R454C, R455A, R513A, R515A, R515B)
HC (R290, R600, R600A, R1270)

These valves are sold in both the version without the coil (S suffix) and the version with the coil (A6 suffix for coils at 220 VAC).

Product details

Funtionsprinzip	Kolbenantrieb
Spulentyp (1)	HF2HF3HF4HM2HM3HM4CM2
Anschlüsse ODS Ø [in.]	-
Anschlüsse ODS Ø [mm]	10
Kv [m³/h]	1
PS [bar]	50
TS [°C] (2) min.	-40
TS [°C] (2) max.	+150
Verpackung	24

Notes

(#): für Heißgas-Bypass, Flüssigkeitseinspritzung, Ölleitung

(1) : Spulen, die an den Ventilen montiert werden können

(2): für den Einsatz in der Ölleitung TS = -10 / + 70 ° C