

Product Code

1070N/5A6

Solenoid Valve
5/8"Flare 220-230V
PS = 50 bar

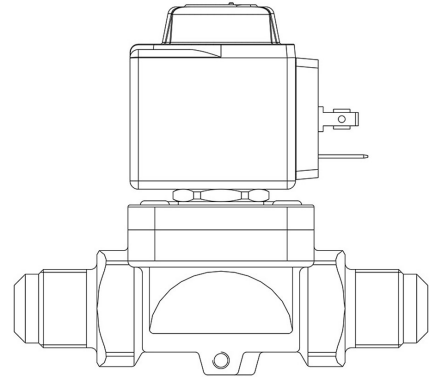

P  **LYHEDRA**

Product use

Accessories for use with the following ASHRAE 34:2019 refrigerants, Class A1, A2L, or A3:
 HFC (R134A, R32, R404A, R407C, R410A, R507)
 HFO (R1234YF, R1234ZE)
 HFO + HFC (R448A, R449A, R450A, R452A, R452B, R454A, R454B, R454C, R455A, R513A, R515A, R515B)
 HC (R290, R600, R600A, R1270)

These valves are sold in both the version without the coil (S suffix) and the version with the coil (A6 suffix for coils at 220 VAC).

Product details

Funtionsprinzip Membranantrieb

Spulentyp (1) HF2

Anschlüsse SAE Flare 5/8"

Kv [m³/h] 2,61

PS [bar] 50

TS [°C] min. -40

TS [°C] max. +120

Verpackung 24

Notes

(1): An den Ventilen montierte Spulen