

Product Code

1164/3S

Solenoid Valve NO
3/8" Flare w/o Coil
PS = 45 bar

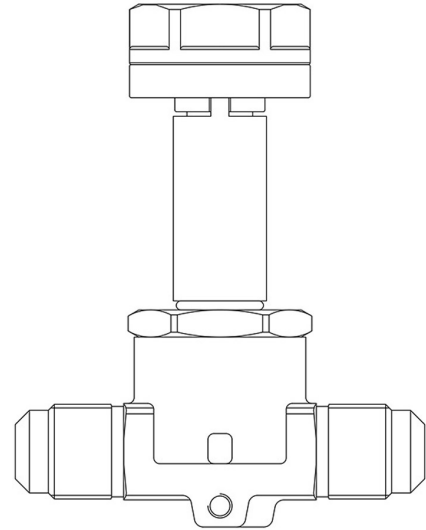

CLASSIC

Product use

Accessories for use with the following ASHRAE 34:2019 refrigerants, Class A1:

- HCFC (R22)
- HFC (R134a, R404A, R407C, R410A, or R507)
- HFO and HFO/HFC blends (R1234ze, R448A, R449A, R450A, R452A, R513A)

Maximum allowable pressure PS = 45 bar.

Allowable temperatures TS = -35 / +105 °C (+110 °C for direct opening).

These valves are exclusively sold in the model without coil (S suffix).

Product details

Funtionsprinzip	Membranantrieb
Spulentyp (1)	HM3
Anschlüsse SAE Flare	3/8"
Kv [m ³ /h]	0,8
PS [bar]	45
TS [°C] min.	-35
TS [°C] max.	+105
Verpackung	18

Notes

Castel non si assume alcuna responsabilità per eventuali errori nei cataloghi, opuscoli e altro materiale stampato o indicato nel sito Castel.it. Castel si riserva il diritto di modificare i propri prodotti senza preavviso. Tutti i marchi in questo materiale sono di proprietà di Castel. Tutti i diritti riservati.

Castel assumes no responsibility for any errors in catalogs, brochures and other material printed or indicated on the Castel.it website. Castel reserves the right to modify its products without notice. All trademarks in this material are the property of Castel. All rights reserved.

Die N.O. Ventile sind ausschließlich für den betrieb mit gleichstromspulen vorgesehen.

Bei verwendung mit wechselstromspeisung ist das N.O. Ventile mit spule 9120/RD6 und verbinder 9150/R45

(1) : Spulen, die an den Ventilen montiert werden können