

Product Code

2028R/M12S08

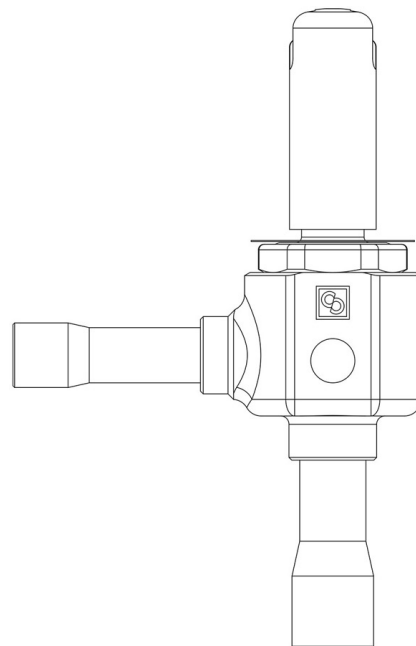

CLASSIC

Product use

Accessories for use with the following ASHRAE 34:2019 refrigerants, Class A1:

HCFC (R22)

HFC (R134a, R404A, R407C, R410A, R507)

HFO (R1234ze)

HFO + HFC (R448A, R449A, R450A, R452A, R513A, R515A, R515B)

These valves are only sold in the model without the coil (S suffix), with 9 nozzles assembled for an increasing output from 1 to 22 kW with R410A.

Product details

Düseneinsatz Typ	08
Anschlüsse In Ø [in.]	-
Anschlüsse In Ø [mm]	12
Out Ø [in.]	-
Out Ø [mm]	16
Kv [m ³ /h]	0,23
Nennleistungen R23 (1) [kW]	25,8
PS [bar]	45
TS [°C] min.	-80
TS [°C] max.	+60

Castel non si assume alcuna responsabilità per eventuali errori nei cataloghi, opuscoli e altro materiale stampato o indicato nel sito Castel.it. Castel si riserva il diritto di modificare i propri prodotti senza preavviso. Tutti i marchi in questo materiale sono di proprietà di Castel. Tutti i diritti riservati.

Castel assumes no responsibility for any errors in catalogs, brochures and other material printed or indicated on the Castel.it website. Castel reserves the right to modify its products without notice. All trademarks in this material are the property of Castel. All rights reserved.

Notes

(1) Nennleistungen basieren auf:

- Verdampfungstemperatur $T_{\text{verd}} = - 30 \text{ }^{\circ}\text{C}$
- Kondensationstemperatur $T_{\text{kond}} = - 4 \text{ }^{\circ}\text{C}$
- Temperatur des flüssigen Kältemittels vor dem Ventil $T_{\text{flü}} = - 8 \text{ }^{\circ}\text{C}$