

Product Code

2028R/3S05

PWM Expansion Valve VLT R23

3/8"x1/2" ODS Seat 05

PS = 45 bar

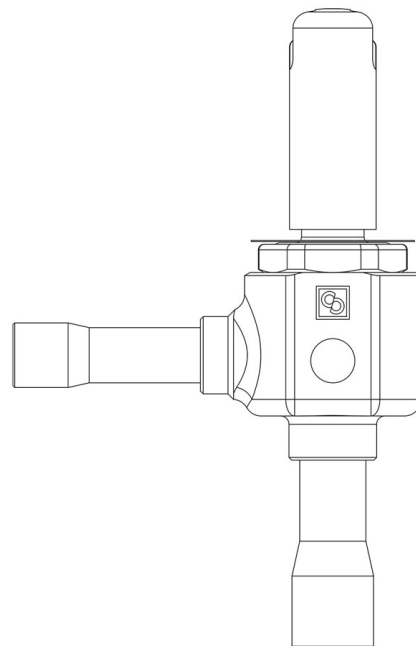

CLASSIC

Product use

Accessories for use with the following ASHRAE 34:2019 refrigerants, Class A1:

HCFC (R22)

HFC (R134a, R404A, R407C, R410A, R507)

HFO (R1234ze)

HFO + HFC (R448A, R449A, R450A, R452A, R513A,
R515A, R515B)

These valves are only sold in the model without the coil (S suffix), with 9 nozzles assembled for an increasing output from 1 to 22 kW with R410A.

Product details

Düseneinsatz Typ 05

Anschlüsse In Ø [in.] 3/8"

Anschlüsse In Ø [mm] -

Out Ø [in.] 1/2"

Out Ø [mm] -

Kv [m³/h] 0,065

Nennleistungen R23 (1) [kW] 9,8

PS [bar] 45

TS [°C] min. -80

TS [°C] max.	+60
--------------	-----

Verpackung	17
------------	----

Notes

(1) Nennleistungen basieren auf:

- Verdampfungstemperatur $T_{\text{verd}} = - 30 \text{ °C}$

- Kondensationstemperatur $T_{\text{kond}} = - 4 \text{ °C}$

- Temperatur des flüssigen Kältemittels vor dem Ventil $T_{\text{flü}} = - 8 \text{ °C}$