

Product Code

2028R/3S01

PWM Expansion Valve VLT R23

3/8"x1/2" ODS Seat 01

PS = 45 bar

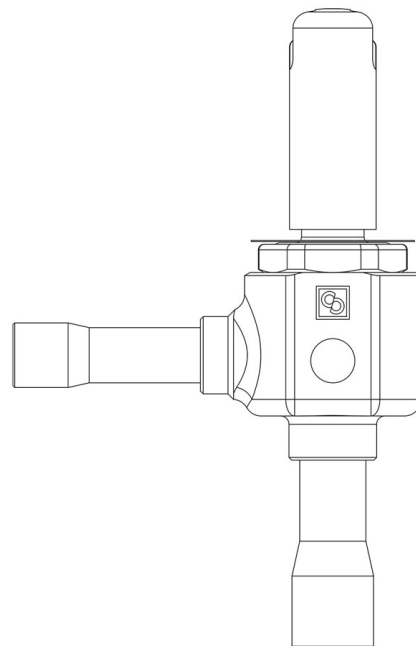

CLASSIC

Product use

Accessories for use with the following ASHRAE 34:2019 refrigerants, Class A1:

HCFC (R22)

HFC (R134a, R404A, R407C, R410A, R507)

HFO (R1234ze)

HFO + HFC (R448A, R449A, R450A, R452A, R513A, R515A, R515B)

These valves are only sold in the model without the coil (S suffix), with 9 nozzles assembled for an increasing output from 1 to 22 kW with R410A.

Product details

Düseneinsatz Typ	01
Anschlüsse In Ø [in.]	3/8"
Anschlüsse In Ø [mm]	-
Out Ø [in.]	1/2"
Out Ø [mm]	-
Kv [m ³ /h]	0,01
Nennleistungen R23 (1) [kW]	1,5
PS [bar]	45
TS [°C] min.	-80

TS [°C] max.	+60
--------------	-----

Verpackung	17
------------	----

Notes

(1) Nennleistungen basieren auf:

- Verdampfungstemperatur $T_{\text{verd}} = - 30 \text{ °C}$

- Kondensationstemperatur $T_{\text{kond}} = - 4 \text{ °C}$

- Temperatur des flüssigen Kältemittels vor dem Ventil $T_{\text{flü}} = - 8 \text{ °C}$