

Product Code

2028/M12S07

PWM Expansion Valve
12mmx16mm ODS Seat 07
PS = 45 bar

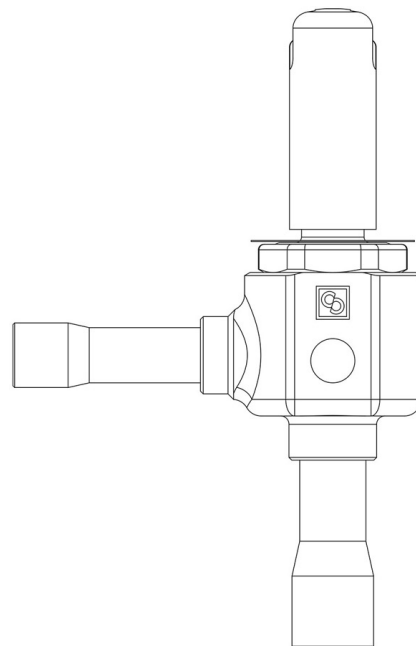

CLASSIC

Product use

Accessories for use with the following ASHRAE 34:2019 refrigerants, Class A1:

HCFC (R22)

HFC (R134a, R404A, R407C, R410A, R507)

HFO (R1234ze)

HFO + HFC (R448A, R449A, R450A, R452A, R513A,
R515A, R515B)

These valves are only sold in the model without the coil (S suffix), with 9 nozzles assembled for an increasing output from 1 to 22 kW with R410A.

Product details

Düseneinsatz Typ	07
Anschlüsse In Ø [in.]	-
Anschlüsse In Ø [mm]	12
Out Ø [in.]	-
Out Ø [mm]	16
Kv [m ³ /h]	0,2
PS [bar]	45
TS [°C] min.	-40
TS [°C] max.	+100

Notes

für Nennleistungen siehe Tabelle der Austrittsanordnungen