

## Product Code

# 3132EW/2

Check Valve CO2

1/4"ODS

PS = 80 bar - 1160 PSI

**G O G R E E N**

R744 • NATURAL REFRIGERANT

### Product use

Accessories for use with refrigerant R744.

### Product details

Anschlüsse ODS Ø [in.] 1/4"

Anschlüsse ODS Ø [mm] -

W Ø [mm] -

Kv [m<sup>3</sup>/h] 0,5

Differenzial Druck (2) [bar] 0,04

PS [bar] 80

MWP [psi] (1) 1160

TS [°C] min. -40

TS [°C] max. +150

Verpackung 25

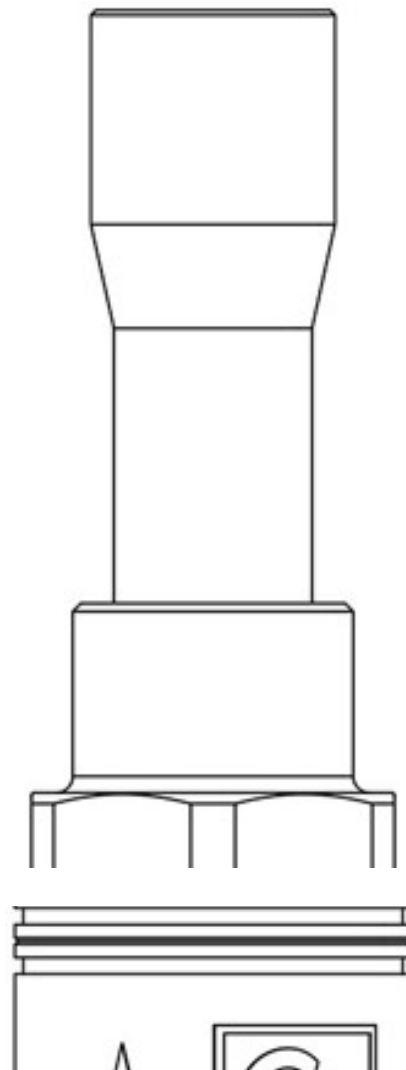

### Notes

(1): Übereinstimmung zur UL-Zulassung

(2): minimaler Druck, bei dem das Ventil vollständig geöffnet ist