

Product Code

3133W/2

Check Valve

1/4"ODS

PS = 50 bar - 600 PSI

POLYHEDRA

CLASSIC

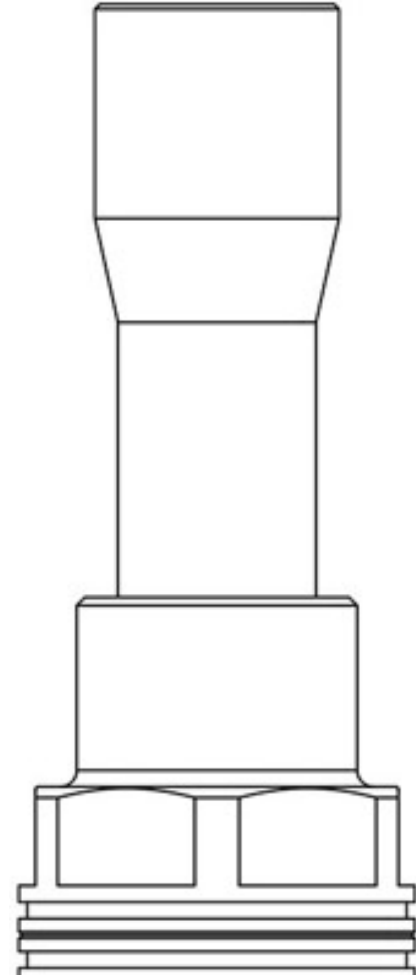

Product use

Accessories for use with the following ASHRAE 34:2019 refrigerants, Class A1:

HCFC (R22)

HFC (R134a, R404A, R407C, R410A, R507)

HFO (R1234ze)

HFO + HFC (R448A, R449A, R450A, R452A, R513A, R515A, R515B)



Product details

Anschlüsse SAE Flare -

Anschlüsse ODS Ø [in.] 1/4"

ODS Ø [mm] -

Kv [m³/h] 0,5

Differenzial Druck (2) [bar] 0,3

PS [bar] 50

MWP [psi] (1) 600

TS [°C] Min -40

TS [°C] Max +150

Verpackung 25

Castel non si assume alcuna responsabilità per eventuali errori nei cataloghi, opuscoli e altro materiale stampato o indicato nel sito Castel.it. Castel si riserva il diritto di modificare i propri prodotti senza preavviso. Tutti i marchi in questo materiale sono di proprietà di Castel. Tutti i diritti riservati.

Castel assumes no responsibility for any errors in catalogs, brochures and other material printed or indicated on the Castel.it website. Castel reserves the right to modify its products without notice. All trademarks in this material are the property of Castel. All rights reserved.

Notes

(1): Übereinstimmung zur UL-Zulassung

(2): minimaler Druck, bei dem das Ventil vollständig geöffnet ist