

Product Code

5690/X15

Oil Level Regulator Adapter
Flanged 3 holes D. 1.7/8"-4 holes D. 50
PS = 140 bar

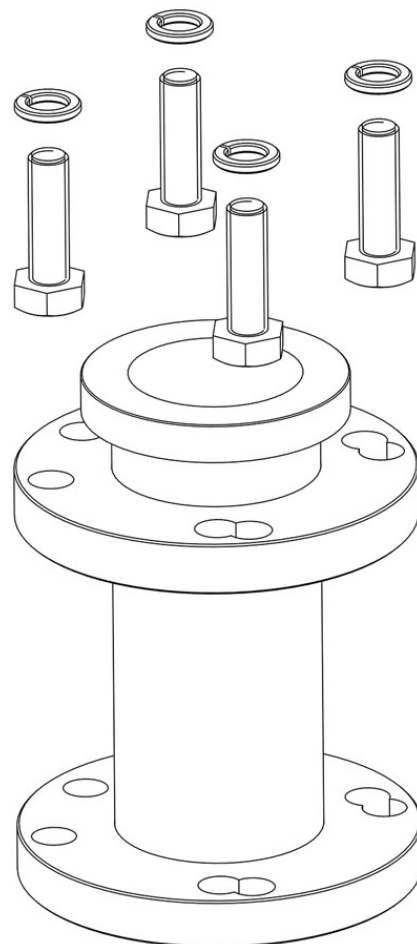

Product use

The oil regulators ensure monitoring and control of the oil level in the crankcases of both alternative reciprocating and scroll compressors. Specifically, these regulators are employed to resolve the problem of incorrect oil distribution in multiple compressor plants.

- Refrigerant CO2 (R744)

Product details

Zeichnung

Katalog Nr 5690/X15

Verdichter-Kurbelgehäuse Ansc Flansch mit 3 Löcher vom Ø 1.7/8" und 4 Löcher vom Ø 50 mmL = 53 mm

Verpackung 5

Notes

(1) inklusive Schrauben zur Befestigung des Adapters am Ölspiegelregulator