

Product Code

27236/7

Electronic Expansion Valve
7/8" ODS
PS = 50 bar

P  **LYHEDRA**

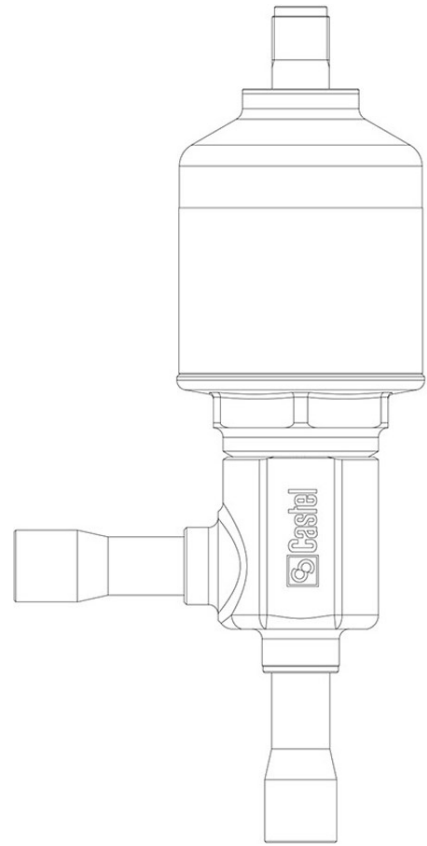

Product use

Castel step-motor expansion valves series 271, 272, 273 regulate the flow of the liquid refrigerant into evaporators by modulating the valve shutter position in a calibrated orifice, allowing a wide capacity regulation range.

Accessories for use with the following ASHRAE 34:2019 refrigerants, Class A1, A2L, or A3:

HFC (R134A, R32, R404A, R407C, R410A, R507)

HFO (R1234YF, R1234ZE)

HFO + HFC (R448A, R449A, R450A, R452A, R452B, R454A, R454B, R454C, R455A, R513A, R515A, R515B)

HC (R290, R600, R600A, R1270)

Product details

Anschlüsse In Ø [in.] 7/8"

Anschlüsse In Ø [mm] 7/8"

Out Ø [in.] 22

Out Ø [mm] 22

PS [bar] 50

TS [°C] min. -40

TS [°C] max.	+60
Spannung [V]	9
Leistung [W]	5,4
Schritte	415
Schutz - klasse	IP65
Verpackung	5

Notes

Bipolarer Schrittmotor mit Permanentmagneten