

Product Code

**2028EX/M12A607**

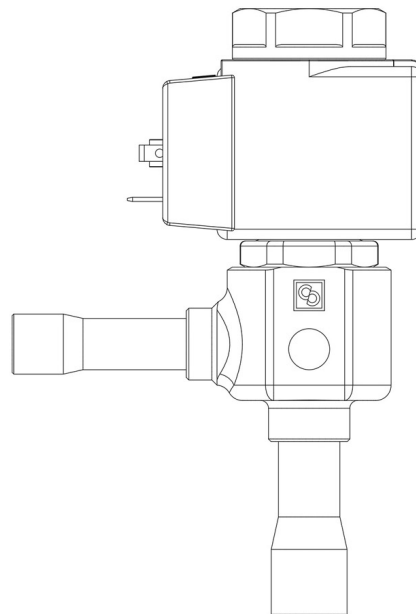

**POLYHEDRA**

## Product use

Solenoid expansion valves with the "EX" suffix are compliant with the ESR of Directive 2014/34/EU "ATEX". This equipment is suitable for use on refrigeration systems located in areas classified as "Zone 2" risk of explosion, according to the definition in Annex I of Directive 1999/92/EC.

Accessories for use with the following ASHRAE 34:2019 refrigerants, Class A1, A2L, or A3:

HFC (R134A, R32, R404A, R407C, R410A, R507)

HFO (R1234YF, R1234ZE)

HFO + HFC (R448A, R449A, R450A, R452A, R452B, R454A, R454B, R454C, R455A, R513A, R515A, R515B)

HC (R290, R600, R600A, R1270)

These valves are only sold in the model with the ATEX certified coil (A6 suffix), with 9 nozzles assembled for an increasing output from 2 to 36 kW with R290.

## Product details

Düseneinsatz Typ	07
Anschlüsse In Ø [in.]	-
Anschlüsse In Ø [mm]	12
Out Ø [in.]	-
Out Ø [mm]	16
Kv [m <sup>3</sup> /h]	0,2
PS [bar]	50
TS [°C] min.	-40

TS [°C] max. +100

Verpackung 15

## Notes

für Nennleistungen siehe Tabelle der Austrittsanordnungen