

Product Code

2028EX/3A601

PWM Expansion Valve - ATEX
3/8"x1/2" ODS Seat 01 - 220/230V
PS = 50 bar

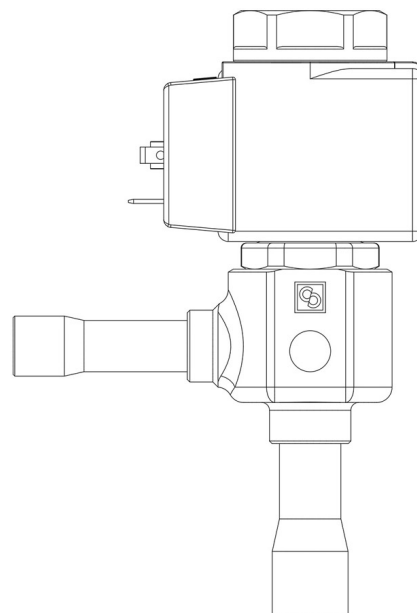

P  **LYHEDRA**

Product use

Solenoid expansion valves with the "EX" suffix are compliant with the ESR of Directive 2014/34/EU "ATEX". This equipment is suitable for use on refrigeration systems located in areas classified as "Zone 2" risk of explosion, according to the definition in Annex I of Directive 1999/92/EC.

Accessories for use with the following ASHRAE 34:2019 refrigerants, Class A1, A2L, or A3:

HFC (R134A, R32, R404A, R407C, R410A, R507)

HFO (R1234YF, R1234ZE)

HFO + HFC (R448A, R449A, R450A, R452A, R452B, R454A,

R454B, R454C, R455A, R513A, R515A, R515B)

HC (R290, R600, R600A, R1270)

These valves are only sold in the model with the ATEX certified coil (A6 suffix), with 9 nozzles assembled for an increasing output from 2 to 36 kW with R290.

Product details

Düseneinsatz Typ	01
Anschlüsse In Ø [in.]	3/8"
Anschlüsse In Ø [mm]	-
Out Ø [in.]	1/2"
Out Ø [mm]	-
Kv [m ³ /h]	0,01
PS [bar]	50

TS [°C] min.	-40
TS [°C] max.	+100
Verpackung	15

Notes

für Nennleistungen siehe Tabelle der Austrittsanordnungen