

Product Code

6110N/23

Receiver Valve
1/4"Flarex3/8"NPT
PS = 50 bar

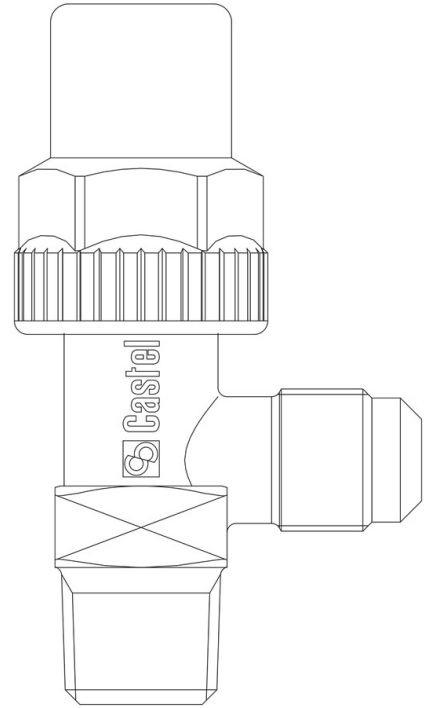

Product use

Accessories for use with the following ASHRAE 34:2019 refrigerants, Class A1, A2L, or A3:
 HFC (R134A, R32, R404A, R407C, R410A, R507)
 HFO (R1234YF, R1234ZE)
 HFO + HFC (R448A, R449A, R450A, R452A, R452B, R454A, R454B, R454C, R455A, R513A, R515A, R515B)
 HC (R290, R600, R600A, R1270)

Product details

Raccord chargement SAE Flare -

Raccords SAE Flare	1/4"
Raccords NPT	3/8"
Kv [m ³ /h]	0,45
PS [bar]	50
TS [°C] min.	-40
TS [°C] max.	+150
Emballage	90