

Product Code

6110E/44

Receiver Valve CO2

1/2"FlareX1/2"NPT

PS = 140 bar

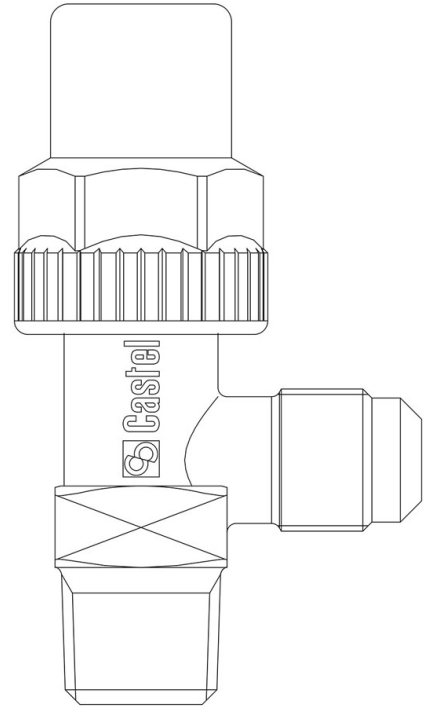

Product use

Accessories for use with refrigerant R744.

Product details

Raccords SAE Flare -

Raccords SAE Flare 1/2"

NPT 1/2"

Kv [m³/h] 3,4

PS [bar] 140

MWP [psi] (3) 2030

TS [°C] min. -40

TS [°C] max. +130

Emballage 20

Notes

(1) : Y compris un joint tronconique 7580/2

(2): peut être installé sans joint

(3): homologation UL en cours