

## Product Code

# 2028/4S09

PWM Expansion Valve

1/2"x5/8" ODS Seat 09

PS = 45 bar

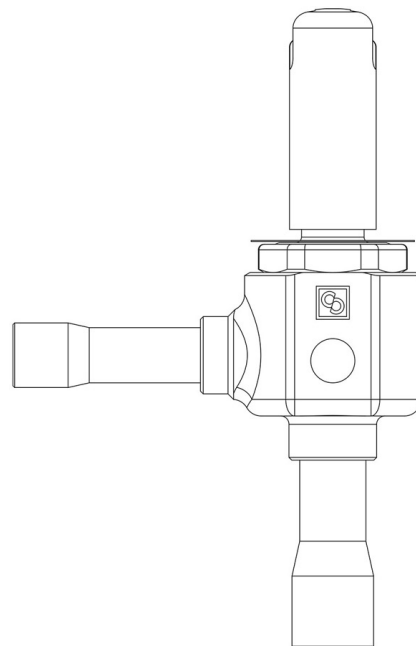

CLASSIC

### Product use

Accessories for use with the following ASHRAE 34:2019 refrigerants, Class A1:

HCFC (R22)

HFC (R134a, R404A, R407C, R410A, R507)

HFO (R1234ze)

HFO + HFC (R448A, R449A, R450A, R452A, R513A, R515A, R515B)

These valves are only sold in the model without the coil (S suffix), with 9 nozzles assembled for an increasing output from 1 to 22 kW with R410A.

### Product details

Type d?orifice	09
Raccords In Ø [in.]	1/2"
Raccords In Ø [mm]	-
Out Ø [in.]	5/8"
Out Ø [mm]	-
Kv [m <sup>3</sup> /h]	0,25
PS [bar]	45
TS [°C] min.	-40
TS [°C] max.	+100

## Notes

pour les capacités nominales voir tableau des ensembles d'orifices