

## Product Code

# 2028EX/3A604

PWM Expansion Valve - ATEX  
3/8"x1/2"ODS Seat 02 - 220/230V  
PS = 50 bar

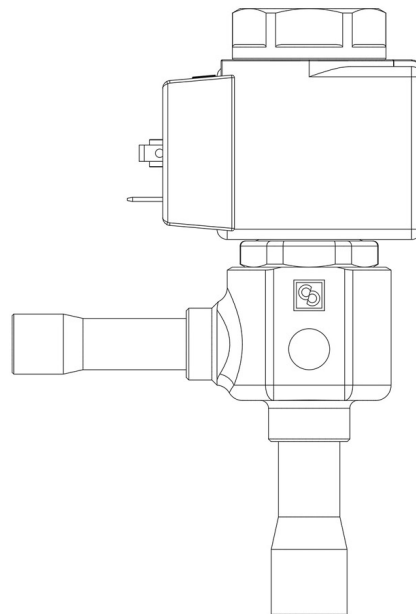

**P**  **LYHEDRA**

### Product use

Solenoid expansion valves with the "EX" suffix are compliant with the ESR of Directive 2014/34/EU "ATEX". This equipment is suitable for use on refrigeration systems located in areas classified as "Zone 2" risk of explosion, according to the definition in Annex I of Directive 1999/92/EC.

Accessories for use with the following ASHRAE 34:2019 refrigerants, Class A1, A2L, or A3:

HFC (R134A, R32, R404A, R407C, R410A, R507)

HFO (R1234YF, R1234ZE)

HFO + HFC (R448A, R449A, R450A, R452A, R452B, R454A,

R454B, R454C, R455A, R513A, R515A, R515B)

HC (R290, R600, R600A, R1270)

These valves are only sold in the model with the ATEX certified coil (A6 suffix), with 9 nozzles assembled for an increasing output from 2 to 36 kW with R290.

### Product details

Type d'orifice	04
Raccords In Ø [in.]	3/8"
Raccords In Ø [mm]	-
Out Ø [in.]	1/2"
Out Ø [mm]	-
Kv [m <sup>3</sup> /h]	0,043
PS [bar]	50

TS [°C] min.	-40
TS [°C] max.	+100
Emballage	15

## Notes

pour les capacités nominales voir tableau des ensembles d'orifices