

Product Code

6698E/M18

3-Ways Manual Ball Valve CO2

18mm W

PS = 140 bar

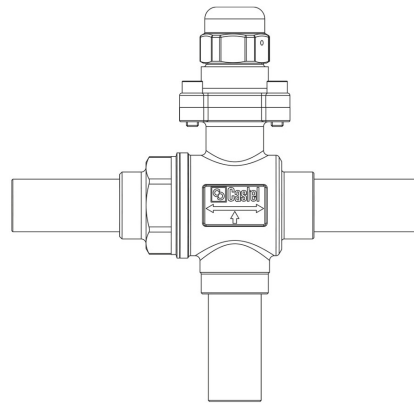

Product use

Accessories for use with refrigerant R744.

Product details

N° Catalogue 6698E/M18

Raccords ODS [mm] 18

Kv [m³/h] 4,6

PS [bar] 140

MWP [psi] (1) 2030

TS[°C] min. -40

TS[°C] max. +150

Emballage 1

Notes

NB: versions à débit proportionnel disponibles

(1): conformément à homologation UL

(2): Pas approuvé UL