

Product Code

6690M/3A2

3-Ways Motorized Ball Valve
3/8" ODS 24V
PS = 45 bar

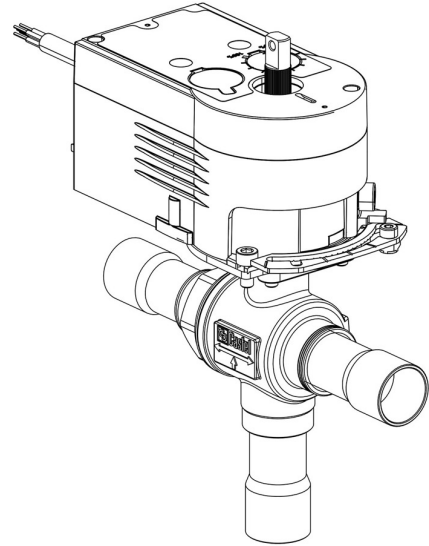

Product use

Accessories for use with the following ASHRAE 34:2019 refrigerants, Class A1:

HCFC (R22)

HFC (R134a, R404A, R407C, R410A, R507)

HFO (R1234ze)

HFO + HFC (R448A, R449A, R450A, R452A, R513A, R515A, R515B)

Product details

N° Catalogue (1) 6690M/3A2

N° Catalogue (1) NEW

Raccords ODS Ø [in.] 3/8"

Raccords ODS Ø [mm] -

W Ø [mm] -

P/N Servomoteur 9700/RA2

Couple [Nm] 10

Orifice bille Ø [mm] 13,5

Kv[m³/h] 4,6

PS[bar] 45

TS[°C] min. -40

TS[°C] max. +150

Emballage 1

Notes

NB: versions à débit proportionnel disponibles
(1) : avec servomoteur et la plaque de montage