

Product Code

6220/7

Diaphragm Valve

7/8" ODS

PS = 28 bar

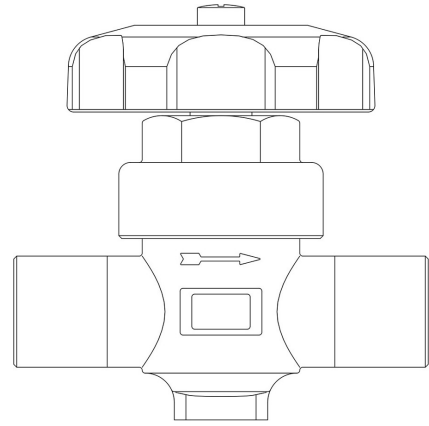

CLASSIC

Product use

Accessories for use with the following ASHRAE 34:2019 refrigerants, Class A1:

HCFC (R22)

HFC (R134a, R404A, R407C, R410A, R507)

HFO (R1234ze)

HFO + HFC (R448A, R449A, R450A, R452A, R513A, R515A, R515B)

Product details

Raccords SAE Flare	-
Raccords ODS Ø [in.]	7/8"
ODS Ø [mm]	-
Kv [m ³ /h]	3,65
PS[bar]	28
TS[°C] min.	-35
TS[°C] max.	+90
Emballage	14