

Product Code

6220/4

Diaphragm Valve

1/2" ODS

PS = 28 bar

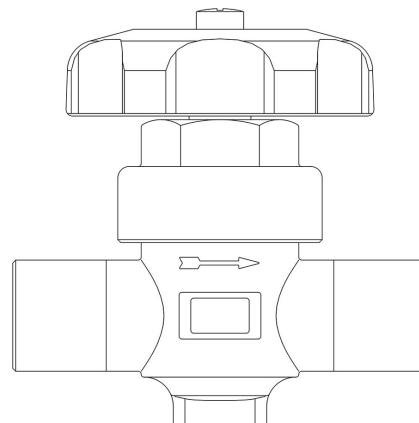

CLASSIC

Product use

Accessories for use with the following ASHRAE 34:2019 refrigerants, Class A1:

HCFC (R22)

HFC (R134a, R404A, R407C, R410A, R507)

HFO (R1234ze)

HFO + HFC (R448A, R449A, R450A, R452A, R513A, R515A, R515B)

Product details

Raccords SAE Flare -

Raccords ODS Ø [in.] 1/2"

ODS Ø [mm] -

Kv [m³/h] 1,3

PS[bar] 28

TS[°C] min. -35

TS[°C] max. +90

Emballage 45