

Product Code

6420N/4

Capped Valve

1/2" ODS

PS = 50 bar

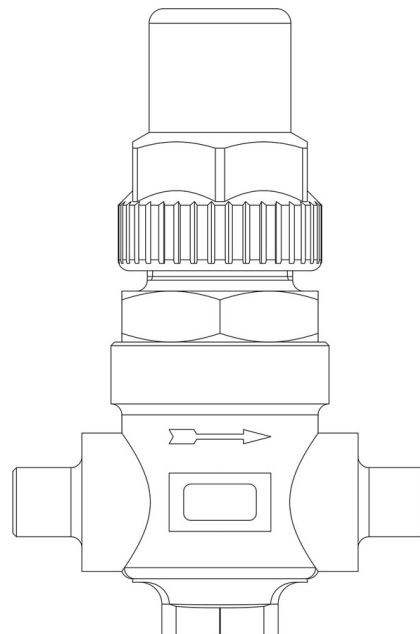

P  **LYHEDRA**

Product use

Accessories for use with the following ASHRAE 34:2019 refrigerants, Class A1, A2L, or A3:
 HFC (R134A, R32, R404A, R407C, R410A, R507)
 HFO (R1234YF, R1234ZE)
 HFO + HFC (R448A, R449A, R450A, R452A, R452B, R454A, R454B, R454C, R455A, R513A, R515A, R515B)
 HC (R290, R600, R600A, R1270)

Product details

Raccords SAE Flare	-
Raccords ODS Ø [in.]	1/2"
ODS Ø [mm]	-
Kv [m ³ /h]	1,45
PS[bar]	50
TS[°C] min.	-40
TS[°C] max.	+130
Emballage	45