

Product Code

3320/7S

Crankcase Pressure Regulator

7/8"-22mm ODS

PS = 28 bar - 405 PSI

CLASSIC

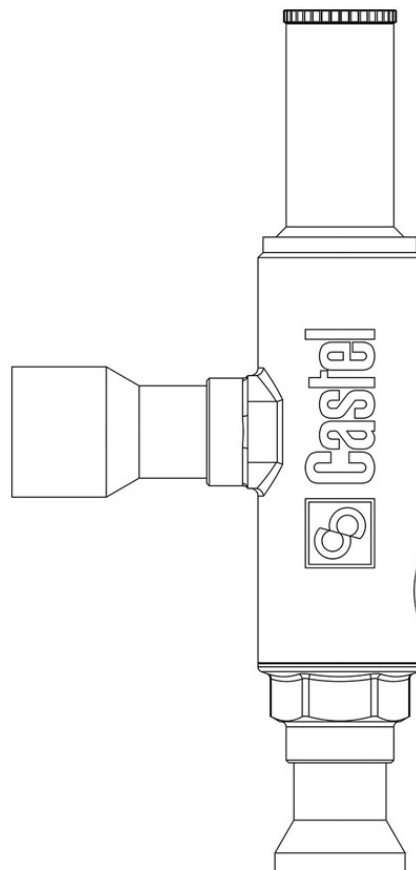

Product use

These are regulators commonly used in low-temperature refrigeration systems. They are designed to prevent the compressor motor from overloading when the intake pressure exceeds the manufacturer's recommended operating pressure.

Accessories for use with the following ASHRAE 34:2019 refrigerants, Class A1:

HCFC (R22)

HFC (R134a, R404A, R407C, R410A, R507)

HFO (R1234ze)

HFO + HFC (R448A, R449A, R450A, R452A, R513A, R515A, R515B)

Product details

Raccords SAE Flare -

Raccords Ø ODS [in.] 7/8"

Ø ODS [mm] 22

Plage de régulation [bar] 0,2 - 6

Kv [m³/h] 3,3

PS [bar] 28

MWP [psi] (1) 406

TS [°C] min. - 40

TS [°C] max. + 110

Emballage 8

Castel non si assume alcuna responsabilità per eventuali errori nei cataloghi, opuscoli e altro materiale stampato o indicato nel sito Castel.it. Castel si riserva il diritto di modificare i propri prodotti senza preavviso. Tutti i marchi in questo materiale sono di proprietà di Castel. Tutti i diritti riservati.

Castel assumes no responsibility for any errors in catalogs, brochures and other material printed or indicated on the Castel.it website. Castel reserves the right to modify its products without notice. All trademarks in this material are the property of Castel. All rights reserved.

Notes

(1): conformément à homologation UL