

## Product Code

# 1190/5S

Solenoid Valve NO

5/8" Flare w/o Coil

PS = 45 bar

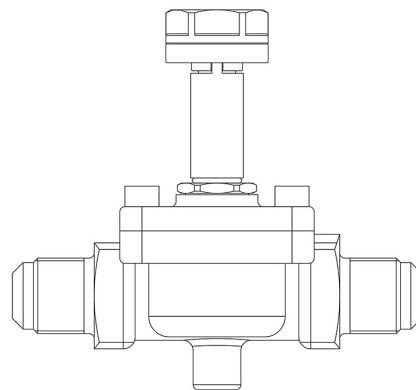

CLASSIC

### Product use

Accessories for use with the following ASHRAE 34:2019 refrigerants, Class A1:

- HCFC (R22)

- HFC (R134a, R404A, R407C, R410A, or R507)

- HFO and HFO/HFC blends (R1234ze, R448A, R449A, R450A, R452A, R513A)

Maximum allowable pressure PS = 45 bar.

Allowable temperatures TS = -35 / +105 °C (+110 °C for direct opening).

These valves are exclusively sold in the model without coil (S suffix).

### Product details

**Principe de fonctionnement** Servocommande à membrane

**Type bobine (1)** HM3

**Raccords SAE Flare** 5/8"

**Kv [m<sup>3</sup>/h]** 3,8

**PS [bar]** 45

**TS [°C] min.** -35

**TS [°C] max.** +105

**Emballage** 14

### Notes

Castel non si assume alcuna responsabilità per eventuali errori nei cataloghi, opuscoli e altro materiale stampato o indicato nel sito Castel.it. Castel si riserva il diritto di modificare i propri prodotti senza preavviso. Tutti i marchi in questo materiale sono di proprietà di Castel. Tutti i diritti riservati.

Castel assumes no responsibility for any errors in catalogs, brochures and other material printed or indicated on the Castel.it website. Castel reserves the right to modify its products without notice. All trademarks in this material are the property of Castel. All rights reserved.

Les vannes N.O. ont été conçus pour le fonctionnement avec des bobines en courant continu uniquement. Pour les applications avec alimentation en courant alternatif, il faut accoupler la vanne N.O. avec la bobine 9120/RD6 et le connecteur 9150/R45.

(1) : bobines pouvant être montées sur des vannes