

Product Code

1338N/M10S065

Pulse Solenoid Valve
10mm ODS w/o Coil
PS = 50 bar

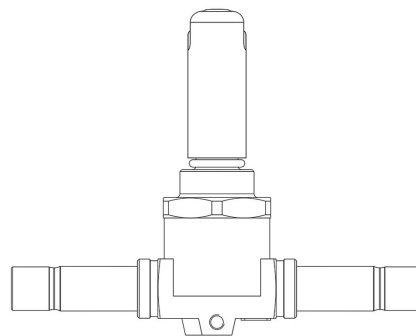

P  **LYHEDRA**

Product use

Accessories for use with the following ASHRAE 34:2019 refrigerants, Class A1, A2L, or A3:
HFC (R134A, R32, R404A, R407C, R410A, R507)
HFO (R1234YF, R1234ZE)
HFO + HFC (R448A, R449A, R450A, R452A, R452B, R454A, R454B, R454C, R455A, R513A, R515A, R515B)
HC (R290, R600, R600A, R1270)

These valves are sold in both the version without the coil (S suffix) and the version with the coil (A6 suffix for coils at 220 VAC).

Product details

Principe de fonctionnement	Servocommande à piston
Type bobine (1)	HF2HF3HF4HM2HM3HM4CM2
Raccords ODS Ø [in.]	-
Raccords ODS Ø [mm]	10
Kv [m³/h]	1
PS [bar]	50
TS [°C] (2) min.	-40
TS [°C] (2) max.	+150
Emballage	24

Notes

(#): pour la dérivation de gaz chaud, injection de liquide, conduite d'huile

(1) : bobines qui peuvent être montés sur les vannes

(2): pour utilisation sur la conduite d'huile TS = -10 / + 70 ° C