

Product Code

1078N/M12A6

Solenoid Valve
12mm ODS 220-230V
PS = 50 bar

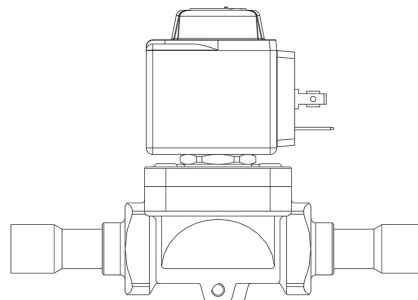

P  **LYHEDRA**

Product use

Accessories for use with the following ASHRAE 34:2019 refrigerants, Class A1, A2L, or A3:
HFC (R134A, R32, R404A, R407C, R410A, R507)
HFO (R1234YF, R1234ZE)
HFO + HFC (R448A, R449A, R450A, R452A, R452B, R454A, R454B, R454C, R455A, R513A, R515A, R515B)
HC (R290, R600, R600A, R1270)

These valves are sold in both the version without the coil (S suffix) and the version with the coil (A6 suffix for coils at 220 VAC).

Product details

Principe de fonctionnement Servocommande à membrane

Type bobine (1) HF2

Raccords ODS Ø [in.] -

Raccords ODS Ø [mm] 12

Kv [m³/h] 2,2

PS [bar] 50

TS [°C] min. -40

TS [°C] max. +120

Emballage 17

Notes

(1) : bobines montés sur des vannes