

Product Code

1064N/4A6

Solenoid Valve
1/2" Flare 220-230V
PS = 50 bar

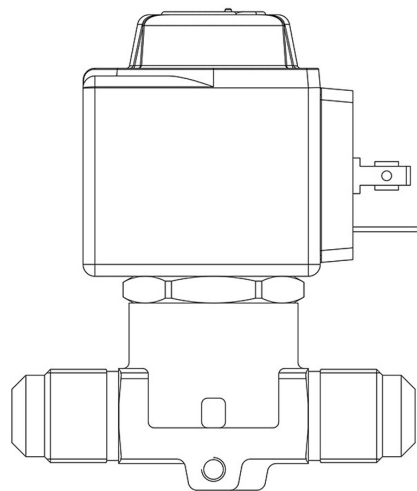

P  **LYHEDRA**

Product use

Accessories for use with the following ASHRAE 34:2019 refrigerants, Class A1, A2L, or A3:
 HFC (R134A, R32, R404A, R407C, R410A, R507)
 HFO (R1234YF, R1234ZE)
 HFO + HFC (R448A, R449A, R450A, R452A, R452B, R454A, R454B, R454C, R455A, R513A, R515A, R515B)
 HC (R290, R600, R600A, R1270)

These valves are sold in both the version without the coil (S suffix) and the version with the coil (A6 suffix for coils at 220 VAC).

Product details

Principe de fonctionnement Servocommande à membrane

Type bobine (1) HF2

Raccords SAE Flare 1/2"

Kv [m³/h] 0,8

PS [bar] 50

TS [°C] min. -40

TS [°C] max. +120

Emballage 18

Notes

(1) : bobines montés sur des vannes