

Product Code

1020N/3S

Solenoid Valve
3/8" Flare w/o Coil
PS = 50 bar

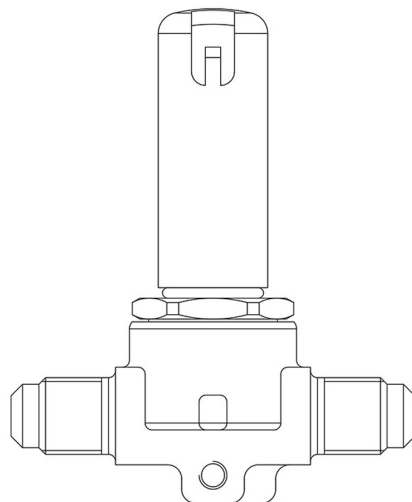

P  **LYHEDRA**

Product use

Accessories for use with the following ASHRAE 34:2019 refrigerants, Class A1, A2L, or A3:
 HFC (R134A, R32, R404A, R407C, R410A, R507)
 HFO (R1234YF, R1234ZE)
 HFO + HFC (R448A, R449A, R450A, R452A, R452B, R454A, R454B, R454C, R455A, R513A, R515A, R515B)
 HC (R290, R600, R600A, R1270)

These valves are sold in both the version without the coil (S suffix) and the version with the coil (A6 suffix for coils at 220 VAC).

Product details

Principe de fonctionnement	Action directe
Type bobine (1)	HF2HF3HF4HM2HM3HM4CM2
Raccords SAE Flare	3/8"
Kv [m³/h]	0,23
PS [bar]	50
TS [°C] min.	-40
TS [°C] max.	+130
Emballage	18

Notes

(1) : bobines qui peuvent être montés sur les vannes