

Product Code

1427E/3S030

Solenoid Valve CO2

3/8" ODS w/o Coil

PS = 130 bar

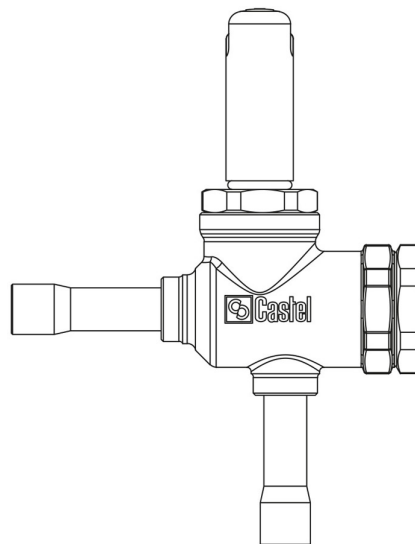

Product use

Accessories for use with refrigerant R744.

These valves are exclusively sold in the model without coil (S suffix).

Product details

Principe de fonctionnement Servocommande à piston

Type bobine (1) HF3

Raccords ODS Ø [in.] 3/8"

Raccords ODS Ø [mm] -

Kv [m³/h] 0,32

PS [bar] 130

MWP [psi] (4) 1885

TS [°C] min. -40

TS [°C] max. +150

Emballage 14

Notes

(1) : bobines qui peuvent être montés sur les vannes

(2): pour utilisation sur la conduite d'huile TS = -10 / + 70 ° C

Castel non si assume alcuna responsabilità per eventuali errori nei cataloghi, opuscoli e altro materiale stampato o indicato nel sito Castel.it. Castel si riserva il diritto di modificare i propri prodotti senza preavviso. Tutti i marchi in questo materiale sono di proprietà di Castel. Tutti i diritti riservati.

Castel assumes no responsibility for any errors in catalogs, brochures and other material printed or indicated on the Castel.it website. Castel reserves the right to modify its products without notice. All trademarks in this material are the property of Castel. All rights reserved.

(3): pour utilisation sur la conduite d'huile contacter CASTEL
(4): homologation UL en cours