

## Product Code

# 1078/M12A6

Solenoid Valve  
12mm ODS 220-230V  
PS = 45 bar

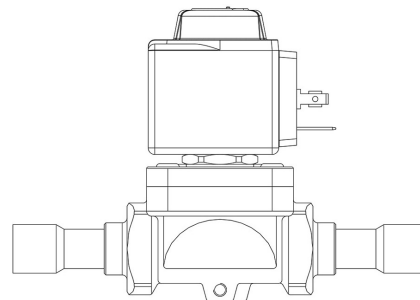

CLASSIC

### Product use

Accessories for use with the following ASHRAE 34:2019 refrigerants, Class A1:

HCFC (R22)

HFC (R134a, R404A, R407C, R410A, R507)

HFO (R1234ze)

HFO + HFC (R448A, R449A, R450A, R452A, R513A, R515A, R515B)

These valves are sold in both the version without the coil (S suffix) and the version with the coil (A6 suffix for coils at 220 VAC and A7 suffix for coils at 240 VAC).

### Product details

**Principe de fonctionnement** Servocommande à membrane

**Type bobine (1)** HF2

**Raccordi ODS Ø [in.]** -

**Raccordi ODS Ø [mm]** 12

**Kv [m<sup>3</sup>/h]** 2,2

**PS [bar]** 45

**TS [°C] min.** -35

**TS [°C] max.** +105

**Emballage** 17

## Notes

(1) : bobines montés sur des vannes