

Product Code

1064/4S

Solenoid Valve
1/2" Flare w/o Coil
PS = 45 bar

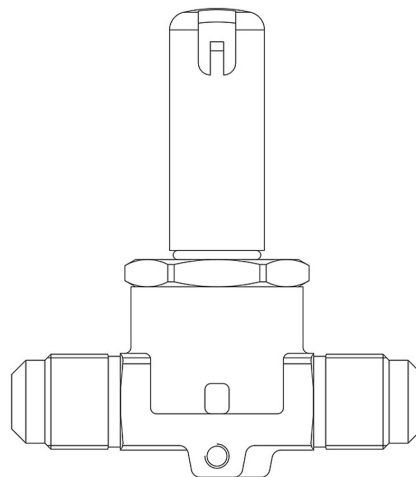

CLASSIC

Product use

Accessories for use with the following ASHRAE 34:2019 refrigerants, Class A1:

HCFC (R22)

HFC (R134a, R404A, R407C, R410A, R507)

HFO (R1234ze)

HFO + HFC (R448A, R449A, R450A, R452A, R513A, R515A, R515B)

These valves are sold in both the version without the coil (S suffix) and the version with the coil (A6 suffix for coils at 220 VAC and A7 suffix for coils at 240 VAC).

Product details

Principe de fonctionnement Servocommande à membrane

Type bobine (1) HF2HF3HF4HM2HM3HM4CM2

Raccords SAE Flare 1/2"

Kv [m³/h] 0,8

PS [bar] 45

TS [°C] min. -35

TS [°C] max. +105

Emballage 18

Notes

(1) : bobines qui peuvent être montés sur les vannes