

Product Code

1049/7A6

Solenoid Valve
7/8"-22mm ODS 220-230V
PS = 45 bar

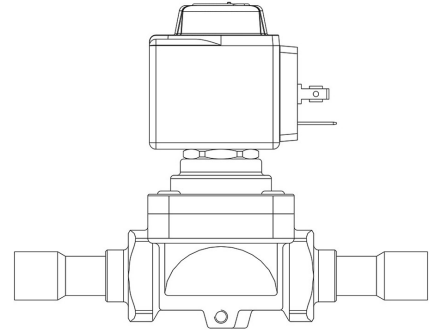

CLASSIC

Product use

Accessories for use with the following ASHRAE 34:2019 refrigerants, Class A1:

HCFC (R22)

HFC (R134a, R404A, R407C, R410A, R507)

HFO (R1234ze)

HFO + HFC (R448A, R449A, R450A, R452A, R513A, R515A, R515B)

These valves are sold in both the version without the coil (S suffix) and the version with the coil (A6 suffix for coils at 220 VAC and A7 suffix for coils at 240 VAC).

Product details

Principe de fonctionnement Servocommande à piston

Type bobine (1) HF2

Raccords ODS Ø [in.] 7/8"

Raccords ODS Ø [mm] 22

Kv [m³/h] 3

PS [bar] 45

TS [°C] min. -35

TS [°C] max. +110

Emballage 14

Notes

(1) : bobines montés sur des vannes