

Product Code

1068EX/M12A6

Solenoid Valve ATEX
12mm ODS 220-230V
PS = 50 bar

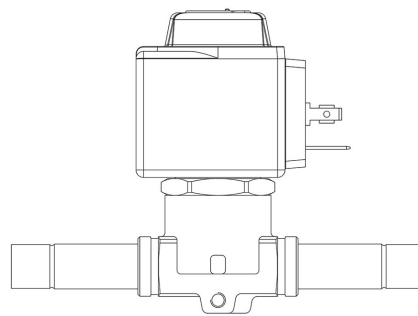

P  **LYHEDRA**

Product use

Solenoid valves with the "EX" suffix are compliant with the ESR of Directive 2014/34/EU "ATEX". This equipment is suitable for use on refrigeration systems located in areas classified as "Zone 2" risk of explosion, according to the definition in Annex I of Directive 1999/92/EC.

Accessories for use with the following ASHRAE 34:2019 refrigerants, Class A1, A2L, or A3:

HFC (R134A, R32, R404A, R407C, R410A, R507)

HFO (R1234YF, R1234ZE)

HFO + HFC (R448A, R449A, R450A, R452A, R452B, R454A, R454B, R454C, R455A, R513A, R515A, R515B)

HC (R290, R600, R600A, R1270)

These valves are only sold in the model with the ATEX certified coil (A6 suffix).

Product details

Principe de fonctionnement Servocommande à membrane

Type bobine (1) HM2(EX)

Raccordi ODS Ø [in.] -

Raccordi ODS Ø [mm] 12

Kv [m³/h] 0,8

PS [bar] 50

TS [°C] min. -40

TS [°C] max. +120

Notes

(1) : bobines montés sur des vannes