

## Product Code

# 3070/44C275

Bursting Disc Safety Device

1/2"x1/2"NPT Pset=27,5bar

PS = 55 bar

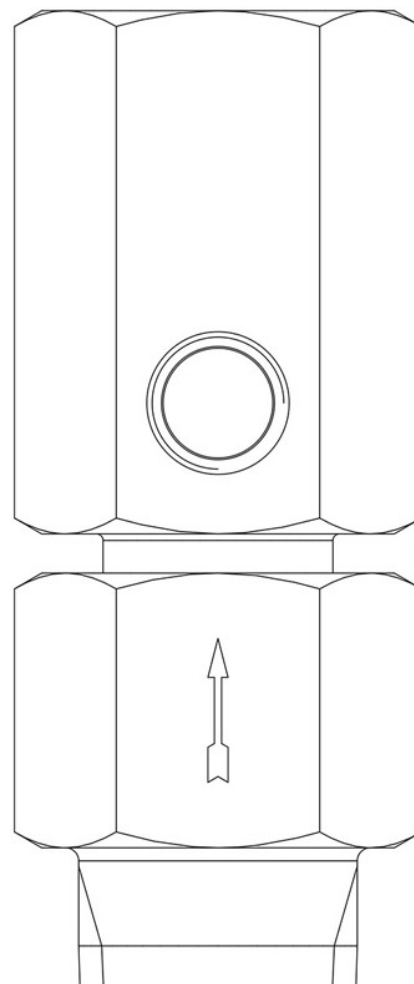

### Product use

Safety device 3070 is a pressure relief device that cannot be closed again, in which a bursting disc is sensitive to a positive differential pressure between the upstream and downstream sections. It is designed to burst at a specified pressure.

Safety accessories for use with the following ASHRAE 34:2019 refrigerants, Class A1:

HCFC (R22)

HFC (R134a, R404A, R407C, R410A, R507)

HFO (R1234ze)

HFO + HFC (R448A, R449A, R450A, R452A, R513A, R515A, R515B)

Available at various burst pressures from 14 to 52 bar.

### Product details

Raccords IN mâle	1/2" NPT
Raccords OUT femelle	1/2" NPT
service	2 x 1/8" NPT
Section orifice [mm <sup>2</sup> ]	113
Pression de rupture Pb [bar]	27,5
Pression d'exercice max.	75 % Pb
PS[bar]	55

<b>TS[°C] min.</b>	-50
<b>TS[°C] max.</b>	+150
<b>Emballage</b>	20