

## Product Code

# 3070/44C250

Bursting Disc Safety Device  
1/2"x1/2"NPT Pset=25,0bar  
PS = 55 bar

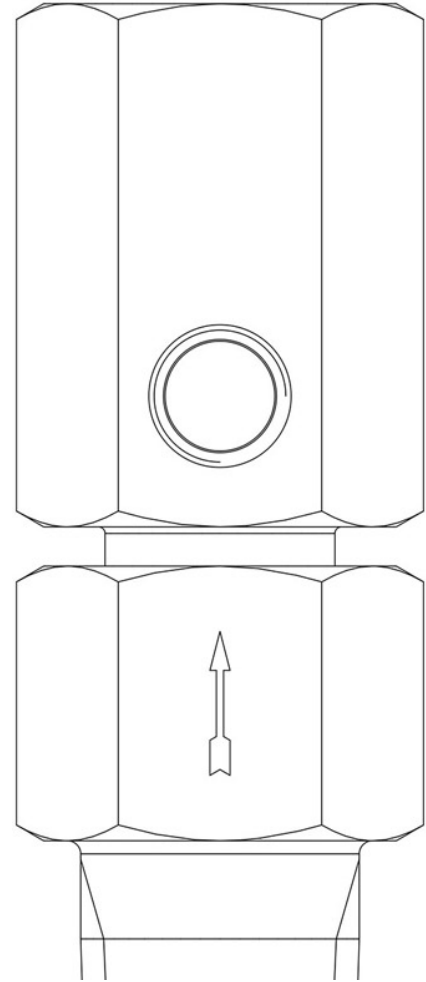

### Product use

Safety device 3070 is a pressure relief device that cannot be closed again, in which a bursting disc is sensitive to a positive differential pressure between the upstream and downstream sections. It is designed to burst at a specified pressure.

Safety accessories for use with the following ASHRAE 34:2019 refrigerants, Class A1:

HCFC (R22)

HFC (R134a, R404A, R407C, R410A, R507)

HFO (R1234ze)

HFO + HFC (R448A, R449A, R450A, R452A, R513A, R515A, R515B)

Available at various burst pressures from 14 to 52 bar.

### Product details

|                                    |              |
|------------------------------------|--------------|
| Raccords IN mâle                   | 1/2" NPT     |
| Raccords OUT femelle               | 1/2" NPT     |
| service                            | 2 x 1/8" NPT |
| Section orifice [mm <sup>2</sup> ] | 113          |
| Pression de rupture Pb [bar]       | 25           |
| Pression d'exercice max.           | 75 % Pb      |
| PS[bar]                            | 55           |

|                    |      |
|--------------------|------|
| <b>TS[°C] min.</b> | -50  |
| <b>TS[°C] max.</b> | +150 |
| <b>Emballage</b>   | 20   |