

Product Code

**3124N/13**

Check Valve

1.5/8" ODS

PS = 50 bar

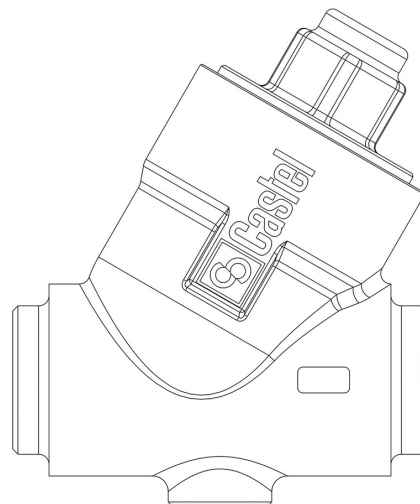

**P**  **LYHEDRA**

### Product use

Accessories for use with the following ASHRAE 34:2019 refrigerants, Class A1, A2L, or A3:

HFC (R134A, R32, R404A, R407C, R410A, R507)

HFO (R1234YF, R1234ZE)

HFO + HFC (R448A, R449A, R450A, R452A, R452B, R454A, R454B, R454C, R455A, R513A, R515A, R515B)

HC (R290, R600, R600A, R1270)

### Product details

Raccords ODS Ø [in.] 1.5/8"

Raccords ODS Ø [mm] -

ODM Ø [in.] 2"

ODM Ø [mm] -

Kv [m<sup>3</sup>/h] 27

Pression différentielle (1) [bar] 0,04

PS [bar] 50

TS [°C] min. -40

TS [°C] max. +150

Emballage 1

## Notes

(1) Pression minimale à laquelle la vanne est entièrement ouverte