

Product Code

3138EW/M16

Check Valve CO2

16mm W

PS = 140 bar - 2030 PSI

G O G R E E N

R744 • NATURAL REFRIGERANT

Product use

Accessories for use with refrigerant R744.

Product details

Raccords ODS Ø [in.] -

Raccords ODS Ø [mm] -

W Ø [mm] 16

Kv [m³/h] 3,3

Pression différentielle (2) [bar] 0,3

PS [bar] 140

MWP [psi] (1) 2030

TS [°C] min. -40

TS [°C] max. +150

Emballage 16

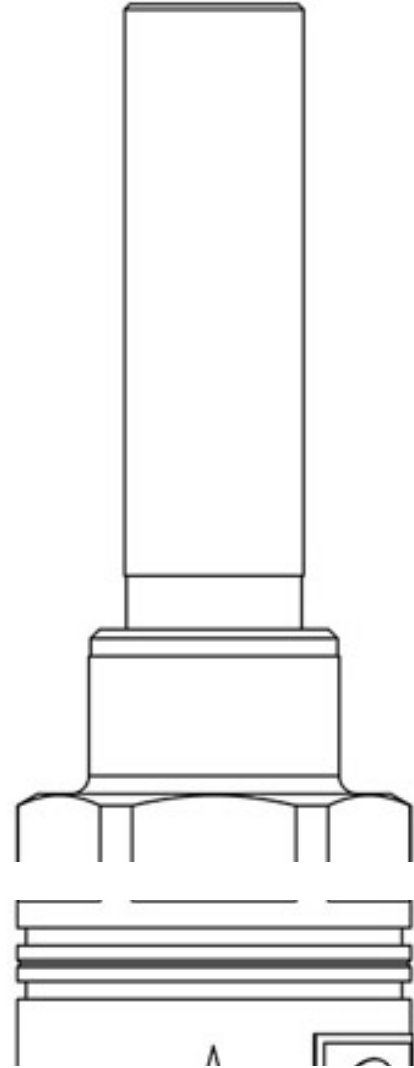

Notes

(1): conformément à homologation UL

(2): pression minimum à laquelle le clapet est complètement ouvert