

## Product Code

# 3137EW/4

Check Valve CO2

1/2" ODS

PS = 130 bar - 1740 PSI

**G O G R E E N**

R744 • NATURAL REFRIGERANT

### Product use

Accessories for use with refrigerant R744.

### Product details

Raccords ODS Ø [in.] 1/2"

Raccords ODS Ø [mm] -

W Ø [mm] -

Kv [m<sup>3</sup>/h] 1,8

Pression différentielle (2) [bar] 0,3

PS [bar] 130

MWP [psi] (1) 1740

TS [°C] min. -40

TS [°C] max. +150

Emballage 16

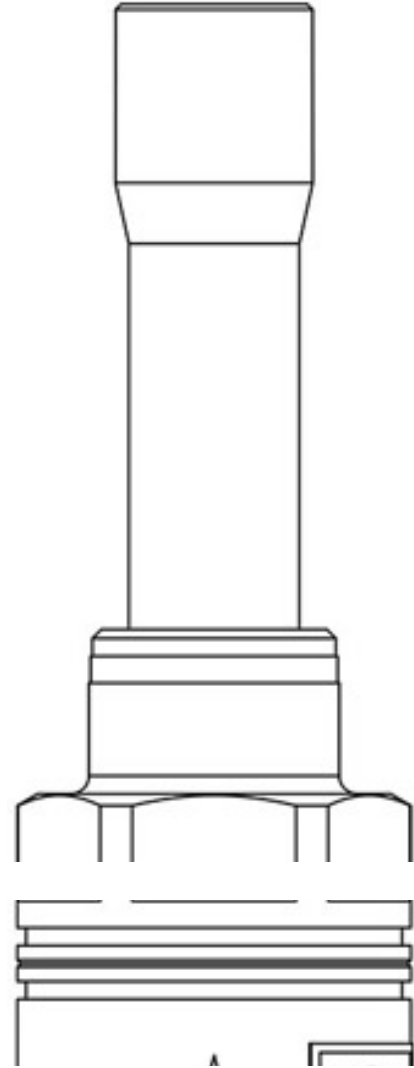

### Notes

(1): conformément à homologation UL

(2): pression minimum à laquelle le clapet est complètement ouvert