

Product Code

3133EW/7

Check Valve CO2
7/8"-22mm ODS
PS = 80 bar - 1160 PSI



Product use

Accessories for use with refrigerant R744.

Product details

Raccords ODS Ø [in.] 7/8"

Raccords ODS Ø [mm] 22

W Ø [mm] -

Kv [m³/h] 5

Pression différentielle (2) [bar] 0,3

PS [bar] 80

MWP [psi] (1) 1160

TS [°C] min. -40

TS [°C] max. +150

Emballage 21

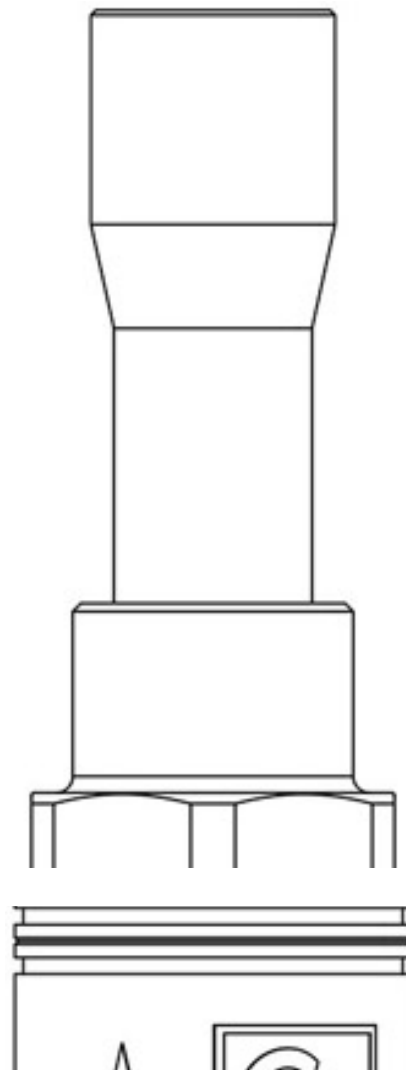

Notes

(1): conformément à homologation UL

(2): pression minimum à laquelle le clapet est complètement ouvert