

## Product Code

# 3132EW/4

Check Valve CO2

1/2" ODS

PS = 80 bar - 1160 PSI

**GO GREEN**

R744 • NATURAL REFRIGERANT

### Product use

Accessories for use with refrigerant R744.

### Product details

Raccords ODS Ø [in.] 1/2"

Raccords ODS Ø [mm] -

W Ø [mm] -

Kv [m<sup>3</sup>/h] 1,8

Pression différentielle (2) [bar] 0,04

PS [bar] 80

MWP [psi] (1) 1160

TS [°C] min. -40

TS [°C] max. +150

Emballage 16

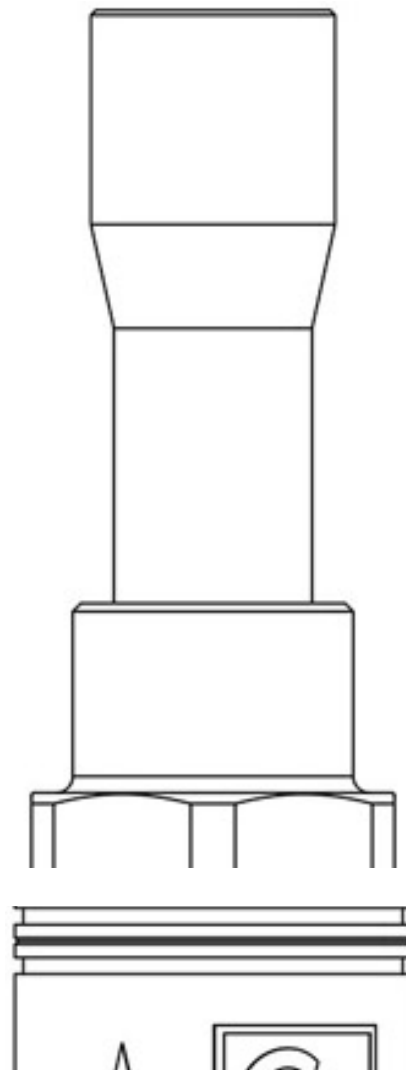

### Notes

(1): conformément à homologation UL

(2): pression minimum à laquelle le clapet est complètement ouvert