

Product Code

3132EW/2

Check Valve CO2

1/4"ODS

PS = 80 bar - 1160 PSI

G O G R E E N

R744 • NATURAL REFRIGERANT

Product use

Accessories for use with refrigerant R744.

Product details

Raccords ODS Ø [in.] 1/4"

Raccords ODS Ø [mm] -

W Ø [mm] -

Kv [m³/h] 0,5

Pression différentielle (2) [bar] 0,04

PS [bar] 80

MWP [psi] (1) 1160

TS [°C] min. -40

TS [°C] max. +150

Emballage 25

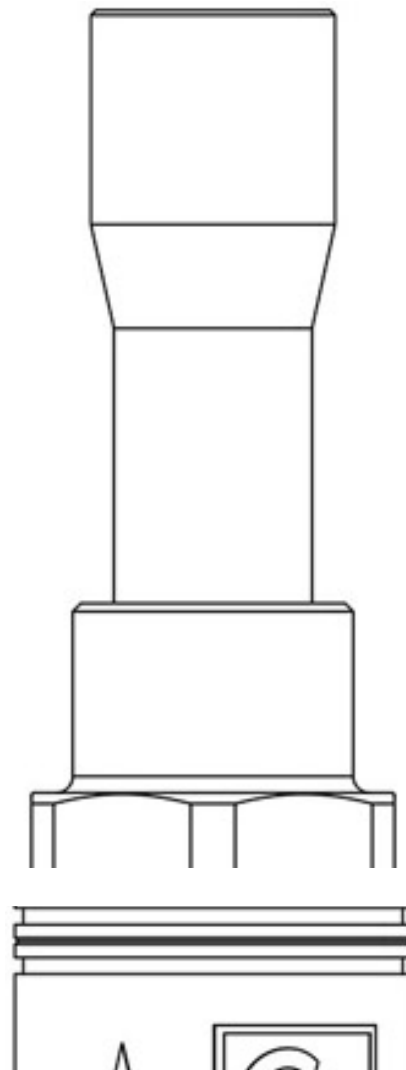

Notes

(1): conformément à homologation UL

(2): pression minimum à laquelle le clapet est complètement ouvert