

Product Code

3080/4C

Fusible Plug

1/2"NPT T=79° C

PS = 42 bar

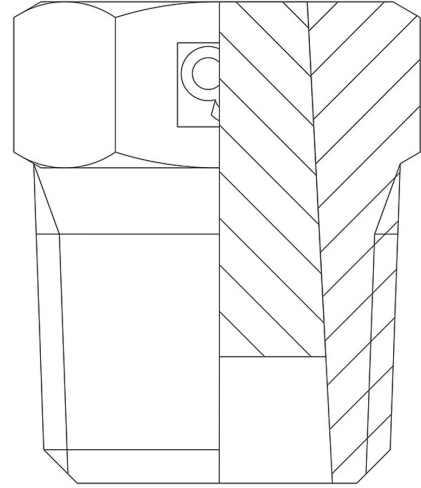

CLASSIC

Product use

Fusible plugs are safety devices that contain a material that melts at a specific temperature and consequently vents the pressure. Safety accessories for use with the following ASHRAE 34:2019 refrigerants, Class A1:

HCFC (R22)

HFC (R134a, R404A, R407C, R410A, R507)

HFO (R1234ze)

HFO + HFC (R448A, R449A, R450A, R452A, R513A, R515A, R515B)

Alloy melting point 79 °C for plugs in series 3080. Alloy melting point 138 °C for plugs in series 3082.

Product details

Raccords NPT 1/2"

Section Orifice [mm²] 67,9

Kd 0,91

PS[bar] 42

Température de fusion [°C] 79

Temperature de service max. [°C] 68

Emballage 0