

Product Code

9150E/R66

Orifice Assemblies CO2
04x2028E

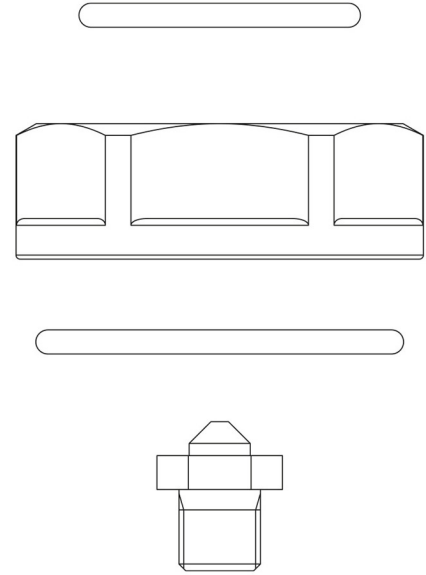

Product use

Accessories for use with refrigerant R744.

These valves are only sold in the model without the coil (S suffix), with 9 nozzles assembled for an increasing output from 2 to 43 kW.

Product details

Orifice type	04
Rated capacity (1) [kW] R744	7,98
Package pcs.	180

Notes

(1) Rated capacities are based on:

- Evaporating temperature $T_{evap} = -25\text{ °C}$
- Condensing temperature $T_{cond} = +0\text{ °C}$
- Refrigerant liquid temperature ahead of valve $T_{liq} = -4\text{ °C}$