

Product Code

1190N/6S

Solenoid Valve NO

3/4"Flare w/o Coil

PS = 50 bar

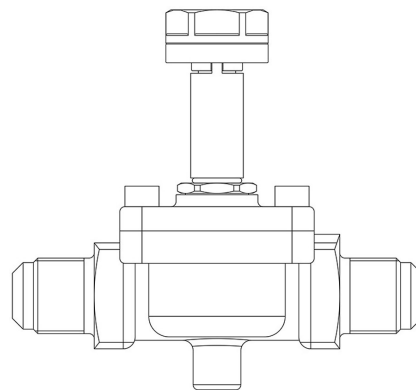

P  **LYHEDRA**

Product use

Accessories for use with the following ASHRAE 34:2019 refrigerants, Class A1, A2L, or A3:
 HFC (R134A, R32, R404A, R407C, R410A, R507)
 HFO (R1234YF, R1234ZE)
 HFO + HFC (R448A, R449A, R450A, R452A, R452B, R454A, R454B, R454C, R455A, R513A, R515A, R515B)
 HC (R290, R600, R600A, R1270)

These valves are exclusively sold in the model without coil (S suffix).

Product details

Operating principle Diaphragm pilot operated

Coil Type (1) HM3

Connections SAE Flare 3/4"

Kv [m³/h] 4,8

PS [bar] 50

TS [°C] min. -40

TS [°C] max. +120

Package Pcs. 14

Notes

The N.O. valves have been designed to work only with direct current coil.

To use them with an alternate current supply it's necessary to mate the N.O. valve with the 9120/RD6 coil and the connector 9150/R45

(1) : coils that can be mounted on the valves