

Product Code

1338N/3S065

Pulse Solenoid Valve

3/8"ODS w/o Coil

PS = 50 bar

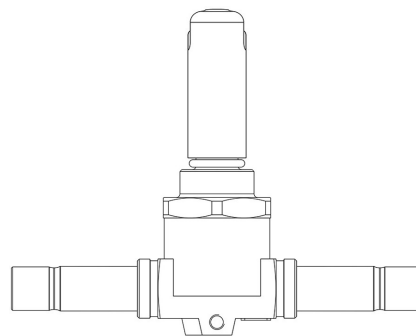

P  **LYHEDRA**

Product use

Accessories for use with the following ASHRAE 34:2019 refrigerants, Class A1, A2L, or A3:

HFC (R134A, R32, R404A, R407C, R410A, R507)

HFO (R1234YF, R1234ZE)

HFO + HFC (R448A, R449A, R450A, R452A, R452B, R454A, R454B, R454C, R455A, R513A, R515A, R515B)

HC (R290, R600, R600A, R1270)

These valves are sold in both the version without the coil (S suffix) and the version with the coil (A6 suffix for coils at 220 VAC).

Product details

Operating principle	Piston pilot operated
Coil Type (1)	HF2HF3HF4HM2HM3HM4CM2
Connections ODS Ø [in.]	3/8"
Connections ODS Ø [mm]	-
Kv [m³/h]	1
PS [bar]	50
TS [°C] (2) min.	-40
TS [°C] (2) max.	+150
Package Pcs.	24

Notes

(#): for hot gas by-pass, liquid injection, oil line

(1) : coils that can be mounted on the valves

(2) : for use on the oil line TS = -10 /+70 °C