

Product Code

1090N/5S

Solenoid Valve
5/8" Flare w/o Coil
PS = 50 bar

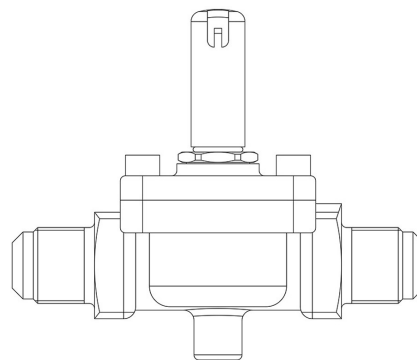

P  **LYHEDRA**

Product use

Accessories for use with the following ASHRAE 34:2019 refrigerants, Class A1, A2L, or A3:
 HFC (R134A, R32, R404A, R407C, R410A, R507)
 HFO (R1234YF, R1234ZE)
 HFO + HFC (R448A, R449A, R450A, R452A, R452B, R454A, R454B, R454C, R455A, R513A, R515A, R515B)
 HC (R290, R600, R600A, R1270)

These valves are sold in both the version without the coil (S suffix) and the version with the coil (A6 suffix for coils at 220 VAC).

Product details

Operating principle Diaphragm pilot operated

Coil Type (1) HF2HF3HF4HM2HM3HM4CM2

Connections SAE Flare 5/8"

Kv [m³/h] 3,8

PS [bar] 50

TS [°C] min. -40

TS [°C] max. +120

Package Pcs. 14

Notes

(1) : coils that can be mounted on the valves